

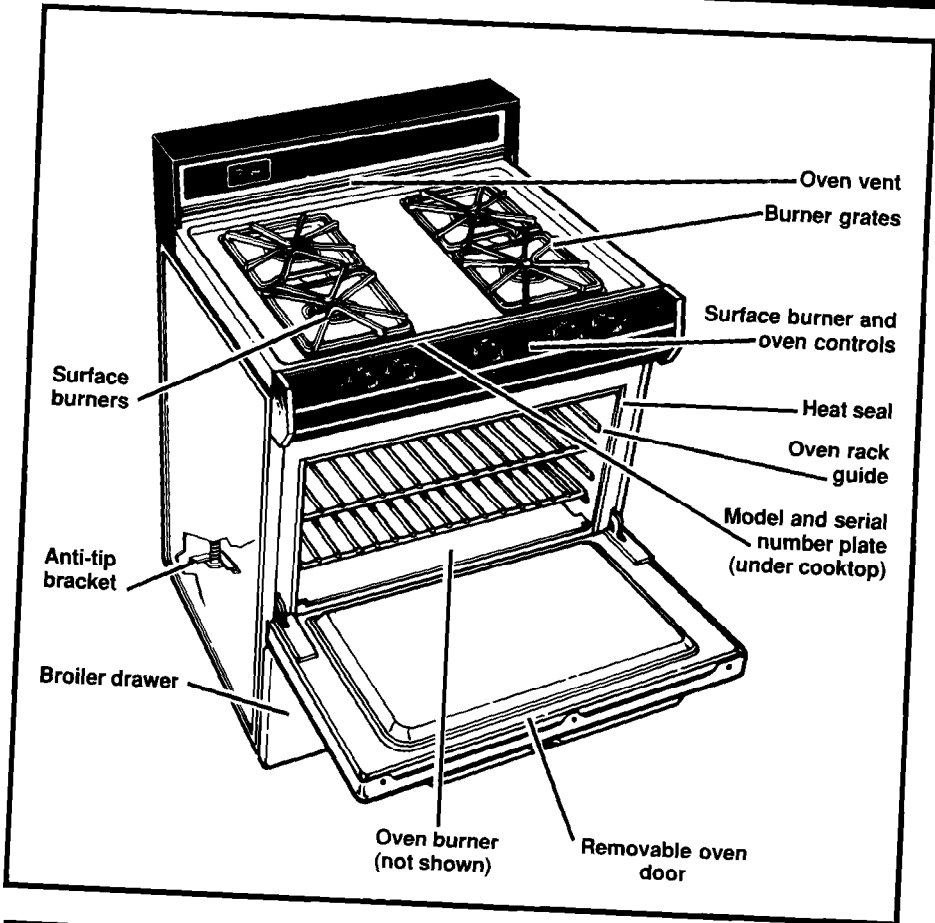

Use & Care Guide



**STANDARD-CLEANING GAS RANGE
SF3000SW/EW**

Contents

	Page
Important Safety Instructions	3
Using Your Range	6
Using the surface burners	6
Lighting standing pilots	7
Using the oven control	8
Baking	8
Adjusting the oven temperature control	9
Broiling	10
The oven vent	11
Caring For Your Range	12
Control panel and knobs	12
Surface burner grates	13
Surface burners	14
Removable cooktop	15
Removable oven door	16
Using the standard-cleaning oven ..	16
Cleaning tips	17
If You Need Service Or Assistance	18
Whirlpool Range Warranty	20

©1990 Whirlpool Corporation

Remove the Consumer Buy Guide label. It will be easier to remove before the range is used. To remove any remaining glue:

- Rub briskly with thumb to make a ball, then remove.
- or
- Soak area with liquid hand dishwashing detergent before removing glue as described above.

Do not use sharp instruments, rubbing alcohol, flammable fluids or abrasive cleaners. These can damage the finish. See "Important Safety Instructions" on page 3.

Thank you for buying a Whirlpool appliance. Please complete and mail the Owner Registration Card provided with this product. Then complete the form below. Have this information ready if you need service or call with a question.

- Copy model and serial numbers from plate (located as shown) and purchase date from sales slip.
- Keep this book, the Cooking Guide and sales slip together in a handy place.

Model Number

Serial Number

Purchase Date

Service Company Phone Number

You are responsible for:

- Installing and leveling the range on a floor strong enough to support its weight, and where it is protected from the elements. (See the Installation Instructions.)
- Making sure the range is not used by anyone unable to operate it properly.
- Properly maintaining the range.
- Using the range only for jobs expected of a home range.
- Making sure the range is secured by properly installed anti-tip bracket(s), with rear leveling leg(s) positioned under bracket(s).

Important Safety Instructions

Gas ranges have been thoroughly tested for safe and efficient operation. However, as with any appliance, there are specific installation and safety precautions which must be followed to ensure safe and satisfactory operation.

⚠ WARNING

To reduce the risk of fire, electrical shock, injury to persons, or damage when using the range, follow basic precautions, including the following:

• FOR YOUR SAFETY •

DO NOT STORE OR USE GASOLINE OR OTHER FLAMMABLE VAPORS AND LIQUIDS IN THE VICINITY OF THIS OR ANY OTHER APPLIANCE. THE FUMES CAN CREATE A FIRE HAZARD OR EXPLOSION.

• FOR YOUR SAFETY •

IF YOU SMELL GAS:

- 1. OPEN WINDOWS.**
- 2. DON'T TOUCH ELECTRICAL SWITCHES.**
- 3. EXTINGUISH ANY OPEN FLAMES.**
- 4. IMMEDIATELY CALL YOUR GAS SUPPLIER.**

IMPROPER INSTALLATION, ADJUSTMENT, ALTERATION, SERVICE OR MAINTENANCE CAN CAUSE INJURY OR PROPERTY DAMAGE. REFER TO THIS MANUAL. FOR ASSISTANCE OR ADDITIONAL INFORMATION CONSULT A QUALIFIED INSTALLER, SERVICE AGENCY, MANUFACTURER (DEALER) OR THE GAS SUPPLIER.

- IMPORTANT -

TO THE INSTALLER: PLEASE LEAVE THIS INSTRUCTION BOOK WITH THE UNIT.

TO THE CONSUMER: PLEASE READ AND KEEP THIS BOOK FOR FUTURE REFERENCE.

Important Safety Instructions Continued

- Install or locate the range only in accordance with the provided Installation Instructions. It is recommended that the range be installed by a qualified installer. The range must be properly connected to the proper gas supply and checked for leaks. The range must also be properly connected to electrical supply and grounded.

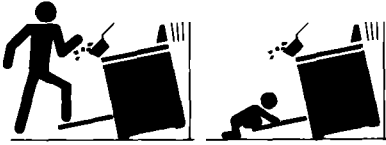

- To reduce the risk of tipping of the appliance, the appliance must be secured by properly installed anti-tip bracket(s). To check if the bracket(s) is installed properly, shine a flashlight under range toward rear corners and verify that the anti-tip bracket(s) is engaged. See Installation Instructions for further details.
- Gas fuels and combustion can result in potential exposure to chemicals known to cause cancer or reproductive harm. For example, benzene is a chemical which is a part of the gas supplied to the range. It is consumed in the flame during combustion. However, exposure to a small amount of benzene is possible if a gas leak occurs. Formaldehyde, carbon monoxide and soot are by-products of incomplete combustion. Properly adjusted burners with a bluish rather than a yellow flame will minimize incomplete combustion.
- Do not operate the range if it is not working properly, or if it has been damaged.
- Do not use the range for warming or heating the room. Persons could be burned or injured, or a fire could start.
- Use the range only for its intended use as described in this manual.
- Do not wear loose or hanging garments when using the range. They could ignite if they touch a hot surface burner and you could be burned.
- Do not touch surface burners, areas near burners or interior surfaces of oven. Areas near surface burners and interior surfaces of an oven become hot enough to cause burns. During use, do not touch, or let clothing or other flammable materials contact surface burners, areas near surface burners or interior surfaces of oven. Other surfaces of the range may become hot enough to cause burns; such as, the oven vent opening, the surface near the vent opening, the cooktop, and the oven door.
- Make sure the utensils you use are large enough to contain food and avoid boil-overs and spill-overs. Heavy splattering or spill-overs left on a range can ignite and burn you. Pan size is especially important in deep fat frying.
- Turn pan handles inward, but not over other surface burners. This will help reduce the chance of burns, igniting of flammable materials, and spills due to bumping of the pan.
- Use only dry potholders. Moist or damp potholders on surface burners may result in burns from steam. Do not let potholder touch surface burners. Do not use a towel or bulky cloth for a potholder. They could catch on fire.
- Check to be sure glass cooking utensils are safe for use on the range. Only certain types of glass, glass-ceramic, ceramic, earthenware or other glazed utensils are

suitable for ranges without breaking due to the sudden change in temperature.

- Do not use decorative covers or trivets over the surface burners.
- Do not heat unopened containers. They could explode. The hot contents could cause burns and container particles could cause injury.
- Grease is flammable and should be handled carefully. Let fat cool before attempting to handle it. Do not allow grease to collect around cooktop or in vents. Wipe spill-overs immediately.
- Do not use water on grease fires. Never pick up a flaming pan. Smother flaming pan on range by covering with a well-fitted lid, cookie sheet or flat tray. Flaming grease outside of pan can be extinguished with baking soda or, if available, a multipurpose dry chemical or foam-type extinguisher.
- Never leave surface burners unattended at high heat settings. A boil-over could result and cause smoking and greasy spill-overs that may ignite.
- Make sure surface burners are off when you are finished, and when you aren't watching.
- Use care when opening oven door. Let hot air or steam escape before removing or replacing food.
- Always position oven racks in desired location while oven is cool.
- Do not store flammable materials on or near the range. They could explode or burn.
- Do not store things children might want above the range. Children could be burned or injured while climbing on it.
- Do not leave children alone or unattended in area where the range is in use. They should never be allowed to sit or stand on any part of the range. They could be burned or injured.
- Never use a match or other flame to look for a gas leak. Explosion and injury could result.
- Know where your main gas shut off valve is located.
- Keep range vents unobstructed.
- Clean your range regularly. See care and cleaning instructions in this manual.
- Be sure all range parts are cool before cleaning.
- Do not clean door heat seal. It is essential for a good seal. Care should be taken not to rub, damage, or move the seal. Clean only parts recommended in this Use and Care Guide.
- Do not repair or replace any part of the range unless specifically recommended in this manual. All other servicing should be referred to a qualified technician.
- Disconnect the electrical supply before servicing the range.

- SAVE THESE INSTRUCTIONS -

Using Your Range

Using the surface burners

Your range is equipped with either standing pilots or electronic ignitors. Standing pilots must be lit initially with a match following the directions on page 7. The pilot light will remain lit when the burners are turned off. To turn a burner on again, just push in and turn the control knob to LITE and the burner will light. Electronic ignitors automatically light the burners each time the control knob is turned to LITE.

Control knobs must be pushed in, then turned to the LITE position. On electronic ignitor models, the clicking sound is the ignition sparking.

To stop the clicking sound after the burner lights, turn the control knob back to a desired setting. The control knob can be set anywhere between HI and OFF.

Surface burner markers

The solid dot in the surface burner marker shows which surface burner is turned on by that knob.

Until you get used to the settings, use the following as a guide. For best results, start cooking at the high settings; then turn the control knob down to continue cooking.

Use LITE to light the burner. After the burner lights, turn control back to a desired setting.

Use HI to start foods cooking; to bring liquids to a boil.

Use a medium setting to continue cooking or to fry chicken or pancakes; for gravy, puddings and icing; to cook large amounts of vegetables.

Use a low setting to keep food warm until ready to serve. Set the heat higher or lower within the low band to keep food at the temperature you want.

NOTE: Do not cook with the control in the LITE position.

In case of a prolonged power failure

Surface burners with electronic ignitors can be manually lighted. Hold a lighted match near a burner and slowly turn the control knob on until the burner lights.

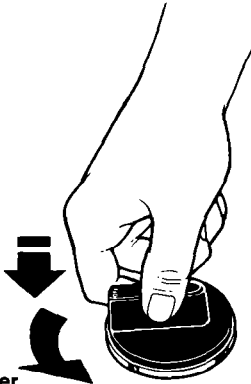

Surface burner marker 

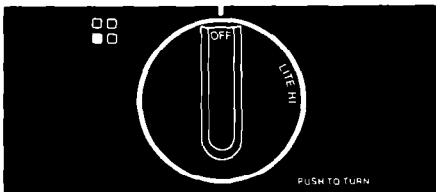

front

After the burner lights, turn the control knob to the desired setting. Power failures will not affect standing pilots.

⚠ WARNING

Burn, Fire and Explosion Hazard

- **Burner flame should not extend beyond the edge of the cooking utensil. The flame can burn you and cause poor cooking results.**
- **Be sure all control knobs are turned to OFF when you are not cooking. Someone could be burned or a fire could start if a burner is accidentally left ON.**
- **If the flame should go out while cooking, or if there is a strong gas odor, turn the burners OFF. Wait five minutes for the gas odor to disappear, before relighting burner. If gas odor is still present, see safety note on page 3. Failure to follow these precautions could result in explosion or fire.**
- **Do not attempt to light the oven burner during a power failure. Personal injury could result.**

Lighting standing pilots

To light range pilots:

1. Make sure all controls are OFF.
2. Remove the surface burner grates from the cooktop. Remove the cooktop. (See "Removable cooktop" on page 15.)

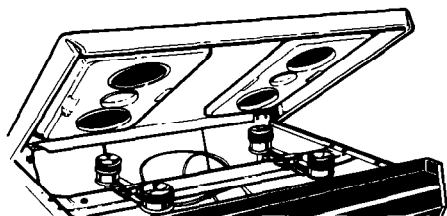

Using Your Range Continued

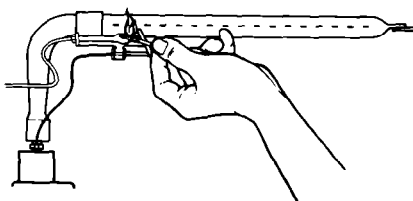
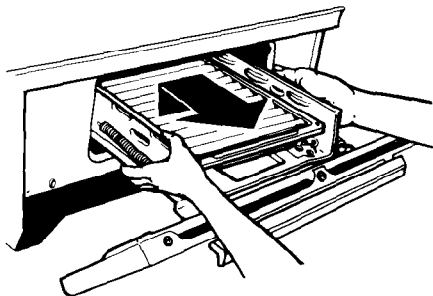
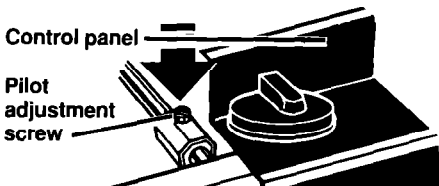
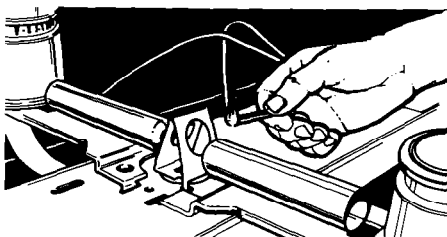

3. **To light**, hold a lit match over the pilot light located between the front and back burners. The pilot flame should be 1/4 to 3/8 in. (.6 - 1 cm) high.

4. If the pilot flame needs adjustment, turn the pilot adjustment screw midway down the length of the manifold pipe, under the control panel.
5. Replace the cooktop and the grates before using the surface burners.

To light oven burner pilot:

1. Make sure the Oven Temperature Control is OFF.
2. Remove the broiler drawer. Slide drawer out to stops, lift both sides, then slide the rest of the way out.
3. Hold a lit match over the oven burner pilot located at the rear of the burner.
4. After the oven burner pilot is burning steadily, check burner lighting by turning the Oven Temperature Control to a temperature above 140°F (60°C). The burner will take 50-60 seconds to light.
5. Replace the broiler drawer.

Using the oven control

Baking

1. Position the rack(s) properly **before** turning on the oven. **To change rack position**, pull rack out to stop, raise front edge and lift out.

The rack(s) should be placed so the top of the food will be centered in the oven. Always leave at least 1 1/2 to 2 inches (4-5 cm) between the sides of the pan and the oven walls and other pans. For more information, see the Cooking Guide.

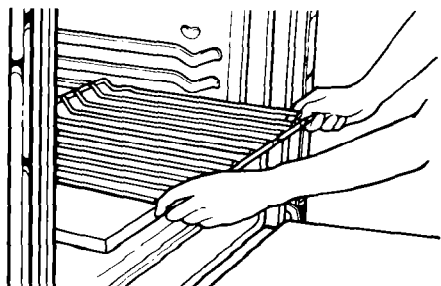

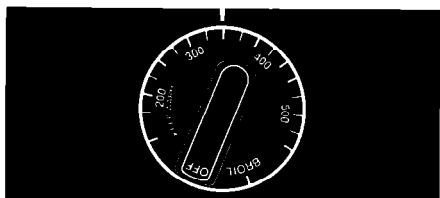

oven temp

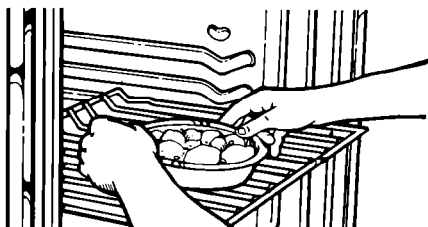

2. Set the Oven Temperature Control to the baking temperature you want. The oven burner will automatically light in 50-60 seconds.

3. Preheat the oven for 10 minutes. Put food in the oven.

NOTE: Do not place food directly on the oven bottom.

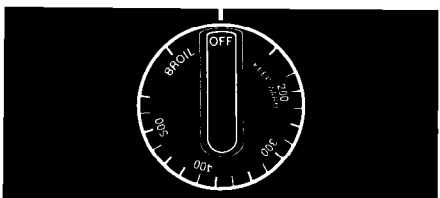

oven temp

4. During baking, the oven burner will turn on and off to maintain the temperature setting.

When baking is done, turn the Oven Temperature Control to OFF.

Adjusting the oven temperature control

Does your oven seem hotter or colder than your old oven? The temperature of your old oven may have shifted gradually without you noticing the change. Your new oven is properly adjusted to provide accurate temperatures. But, when compared to your old oven, the new design may give you different results.

If, after using the oven for a period of time, you are not satisfied with the temperature settings, they can be adjusted by following these steps:

1. Pull the Oven Temperature Control Knob straight off.

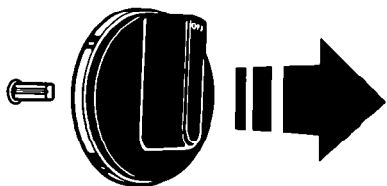

Using Your Range Continued

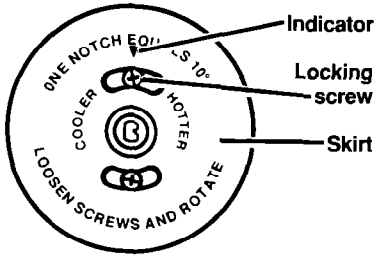

2. Loosen both locking screws. **Note the position of the indicator above the top screw.**

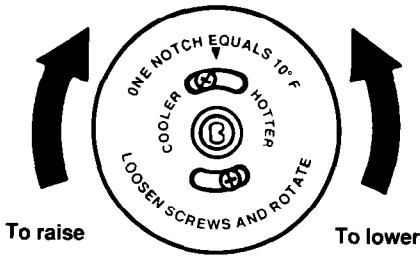

3. **To lower the temperature**, turn skirt counterclockwise one click. Each click equals about 10°F (5°C).
4. **To raise the temperature**, turn skirt clockwise one click. Each click equals about 10°F (5°C).
Tighten the locking screws and replace the control knob.

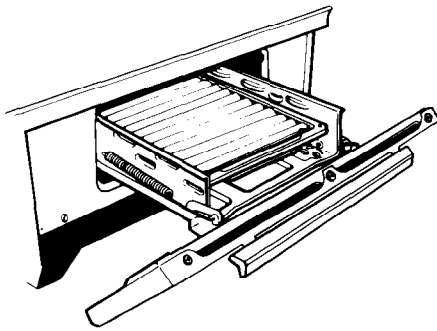

Broiling

The broiler drawer is located below the oven door. **Always broil with the oven door closed.**

1. Pull the broiler drawer open and tilt the door panel down.

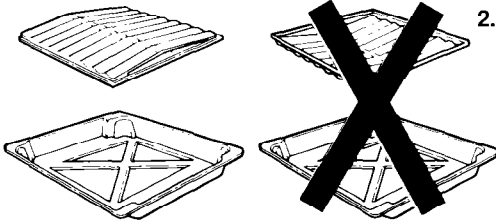

2. Place broiler pan grid so grease can drain down sides into lower part of broiler pan. See picture.

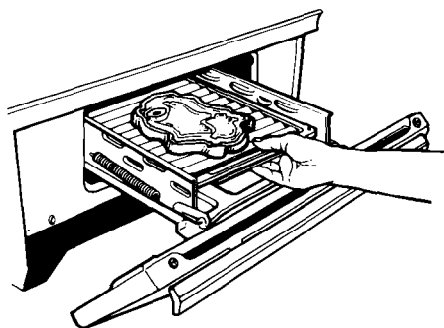

3. Before the broiler is turned on, place food on broiler pan and position the broiler pan at one of the three levels. Refer to a reliable cookbook for broiling chart.

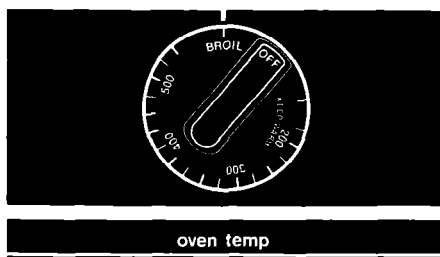

4. Set the Oven Temperature Control to BROIL. The broiler will automatically light in 50-60 seconds.
5. When broiling is done, turn the Oven Temperature Control to OFF.

NOTE: Do not preheat the broiler before using. Completely close the broiler drawer during broiling.

The oven vent

Hot air and moisture escape from the oven through a vent just under the backguard. The vent is needed for air circulation. **Do not block the vent.** Poor baking will result.

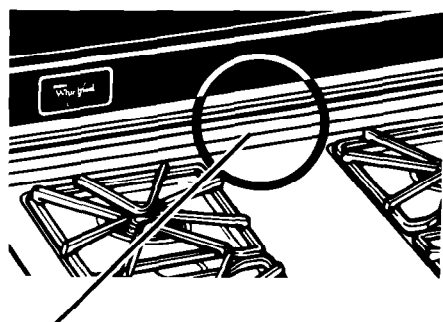

Oven vent

⚠ WARNING

Burn Hazard

When the oven is ON, pans and pan handles left near the oven vent can become hot enough to burn the user and to melt plastics. Use potholders to move pans. Never store plastics, paper or other items that could melt or burn near the oven vent, or any of the surface burners.

Caring For Your Range

⚠ WARNING

Burn, Electrical Shock, Fire and Explosion Hazard

- Make sure all controls are OFF and the range is cool before cleaning.
- Do not use oven cleaners, bleach or rust removers.
- Do not use gasoline or other flammable liquids or vapors to clean this or any other appliance.
- Keep the appliance area clear and free from combustible materials, gasoline and other flammable vapors and liquids.
- Do not obstruct the flow of combustion and ventilation air.

Failure to follow these guidelines could result in burns, electrical shock, fire or explosion.

Control panel and knobs

1. Turn control knobs to the OFF position.
2. Pull control knobs straight off.
3. Use warm soapy water or spray glass cleaner and a soft cloth to wipe the control panels. Rinse and wipe dry with a soft cloth.

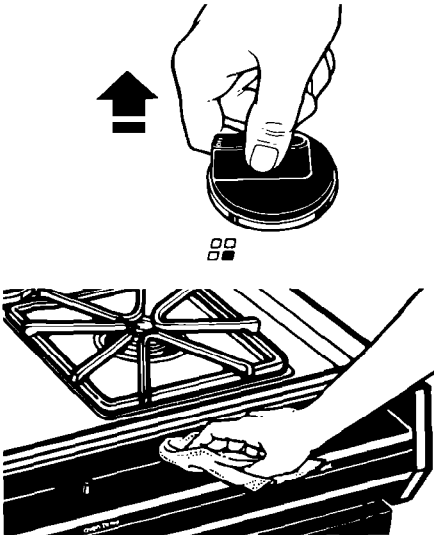



4. Wash control knobs in warm soapy water. Rinse well and dry with a soft cloth. Do not soak.

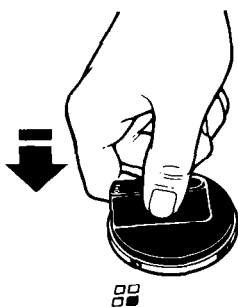

5. Replace control knobs by pushing them firmly into place.

NOTE: When cleaning, never use steel wool, abrasives, or commercial oven cleaners which may damage the finish. After cleaning, make sure all control knobs point to the OFF position.

Surface burner grates

1. Make sure all surface burners are off and the surrounding parts are cool.

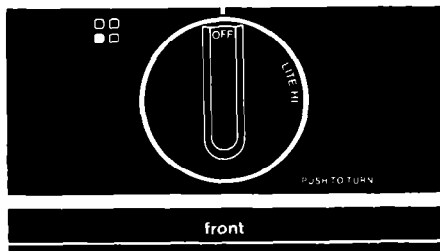

2. Lift off the burner grates.

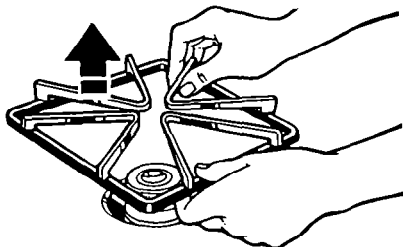

Caring For Your Range Continued

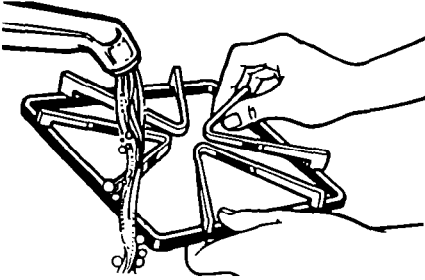

3. Wash the grates with warm soapy water or in a dishwasher. Use a non-abrasive plastic scouring pad for heavily-soiled areas. Rinse and dry well.

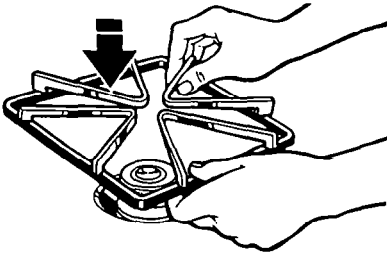

4. Replace burner grates.

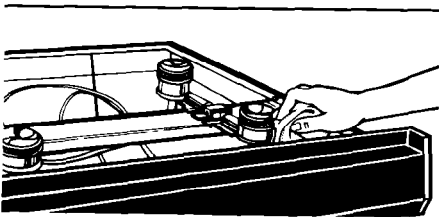

Surface burners

To remove the cooktop, follow the instructions in "Removable cooktop" on page 15.

Wipe off surface burners with warm soapy water and a soft cloth after each use.

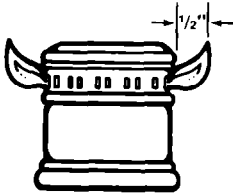

Typical surface burner flame

Occasionally check the burner flames for proper size and shape as shown. If flames lift off ports, are yellow, or are noisy when turned off, you may need to clean the burners (see "Cleaning tips" on page 17), or call a qualified technician for adjustment.

Removable cooktop

1. Remove surface burner grates.

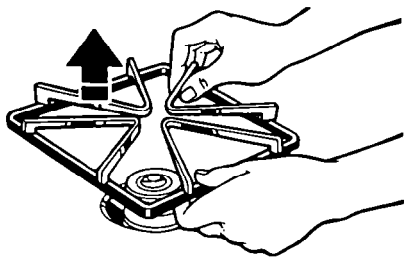

2. Lift front of cooktop enough to clear front of range. Grasp both sides of the cooktop, lift and pull forward to remove.

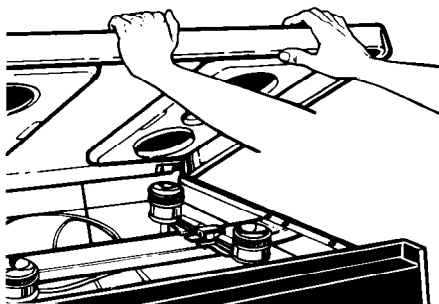

3. Wipe surface under the cooktop with warm soapy water. Use a soap-filled plastic scrubbing pad on heavily-soiled areas.

4. Replace cooktop by fitting back of cooktop into grooves in rear brackets. Lower cooktop. Replace surface burner grates.

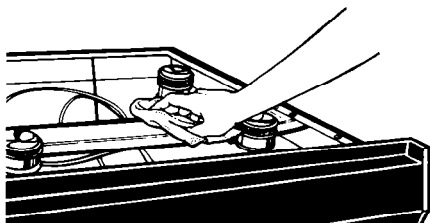

⚠ WARNING

Personal Injury and Product Damage Hazard

- Do not try to clean under the cooktop without removing it first. The cooktop could accidentally fall and injure you.
- Do not drop the cooktop. Damage can result to the porcelain and the cooktop frame.

Removable oven door

Removing the oven door will help make it easier to clean the oven.

⚠ WARNING

Burn and Electrical Shock Hazard
Make sure all controls are OFF and the oven is cool before removing oven door. Failure to do so can result in burns or electrical shock.

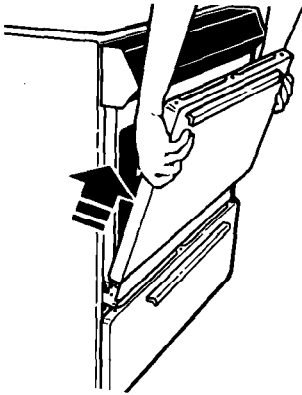

1. Open the door to the first stop position.
2. Hold the door at both sides and lift it **at the same angle it is in.**
3. **To replace**, fit the bottom corners of the door over the ends of the hinges.
Push the door down evenly. The door will close only when it is on the hinges correctly.

Using the standard-cleaning oven

The Standard Oven has to be hand cleaned. Use warm soapy water, soapy steel wool pads or a commercial oven cleaner. See "Cleaning tips" on page 17 for further instructions.

⚠ CAUTION

Do not allow commercial oven cleaner to contact the oven seal, thermostat or exterior surfaces of the oven. Damage will occur.

Using foil

To catch sugar or starch spills from pies and casseroles, use a piece of heavy-duty aluminum foil or a shallow pan on the lower rack, slightly larger than the cooking container. This may, however, result in poor baking.

NOTE: Do not use foil or foil liner to cover the oven floor. Poor baking results could occur.

Cleaning tips

Control knobs

Clean with warm soapy water and a soft cloth.

- Wash, rinse and dry well.
- Do not soak.

Control panel

Clean with warm soapy water or spray glass cleaner and a soft cloth.

- Wash, rinse and dry well.
- Follow directions provided with the cleaner.

Exterior surfaces (other than cooktop)

Clean with warm soapy water and a soft cloth.

- Wipe off regularly when cooktop and oven are cool.

Use a non-abrasive plastic scrubbing pad for heavily-soiled areas.

- Do not use abrasive or harsh cleaners.

NOTE: Do not allow food containing acids (such as vinegar, tomato, lemon juice or milk) to remain on surface. Acids may remove the glossy finish. Be careful when cleaning around model and serial number plate; the numbers wipe off easily.

Surface burners

Clean with warm soapy water and a soft cloth.

- Remove cooktop (see page 15).
- Wipe off spills immediately after burner has cooled.

For cooked-on food:

- Remove burner from manifold with phillips screwdriver.
- Wash with warm soapy water and a non-abrasive plastic scrubbing pad.
- Rinse and dry well.
- If ports are clogged, clean with a straight pin. **Do not enlarge or distort port. Do not use a wooden toothpick.**
- Do not clean surface burner in dishwasher.

Surface burner grates

Clean with warm soapy water and a non-abrasive plastic scrubbing pad.

- Wash, rinse and dry well.
- Dry completely.

OR

Clean in a dishwasher.

Broiler pan and grid

Clean with warm soapy water or a soapy steel wool pad.

- Clean after each use.
- Wash, rinse and dry well.

Oven racks

Clean with warm soapy water or soapy steel wool pads.

- Wash, rinse and dry. Use soapy steel wool pads for heavily-soiled areas.

Standard oven

Clean with warm, soapy water or soapy steel wool pads.

- Remove door for easier access.
- Clean heavily-soiled areas or stains. Rinse well with water.

OR

Use commercial oven cleaners.

- Remove door for easier access.
- Place newspaper on floor to protect floor surface.
- Follow directions provided with the oven cleaner.
- Rinse well with clear water.
- Use in well-ventilated room.
- **Do not allow commercial oven cleaners to contact the oven seal, thermostat or exterior surfaces of the range. Damage will occur.**

Place piece of heavy-duty aluminum foil or shallow pan, slightly larger than the cooking container, on lower rack to catch spill-overs.

If You Need Service Or Assistance...

We suggest you follow these steps:

1. Before calling for assistance...

Performance problems often result from little things you can find and fix without tools of any kind.

If nothing operates:

- Is the gas turned on?
- Is the power supply cord plugged into a live circuit with the proper voltage? (See Installation Instructions.)
- Have you checked your home's main fuses or circuit breaker box?
- Have instructions in this book been followed?
- Is the control knob set in the correct position?
- Is the flow of combustion and/or ventilation air to the unit obstructed? **Do not obstruct air flow to and around unit.**
- Recheck suspected defect.

If burner fails to light:

- Is the range connected to electrical power?
- Have you checked your home's main fuses or circuit breaker box?
- Are burner ports clogged? See page 17.

If burner flames are uneven:

- Are burner ports clogged? See page 17.

If burner flames lift off ports, are yellow, or are noisy when turned off:

- The air/gas mixture may be incorrect. (Call for service.)

If burner makes a popping noise when ON:

- Is the burner wet from washing? Let dry.

If control knob(s) will not turn:

- Did you push in before trying to turn?

If cooking results aren't what you expected:

- Is the range level?
- Does the oven temperature seem too low or too high? See page 9.
- If needed, have you preheated the oven as the recipe calls for?
- Does the flame size fit the cooking utensil being used? (See the Cooking Guide.)
- Are you following a tested recipe from a reliable source?
- Are you using pans recommended in the Cooking Guide?
- If baking, have you allowed 1 1/2 to 2 inches (4-5 cm) on all sides of the pans for air circulation?
- Are the pans the size called for in the recipe?
- Do the cooking utensils have smooth, flat bottoms and fit the surface burners being used?

See the Cooking Guide for more information on cooking problems and how to solve them.

2. If you need assistance*...

Call Whirlpool COOL-LINE® service assistance telephone number. Dial free from anywhere in the U.S.:

1-800-253-1301

and talk with one of our trained consultants. The consultant can instruct you in how to obtain satisfactory operation from your appliance or, if service is necessary, recommend a qualified service company in your area.

If you prefer, write to:

Mr. Donald Skinner
 Director of Consumer Relations
 Whirlpool Corporation
 2000 M-63
 Benton Harbor, MI 49022

Please include a daytime phone number in your correspondence.

3. If you need service*...



Whirlpool has a nationwide network of authorized WhirlpoolSM

service companies. Whirlpool service technicians are trained to fulfill the product warranty and provide after-warranty service, anywhere in the United States. To locate the authorized Whirlpool service company in your area, call our COOL-LINE® service assistance telephone number (see Step 2) or look in your telephone directory Yellow Pages under:

APPLIANCES - HOUSEHOLD - MAJOR - SERVICE & REPAIR ELECTRICAL APPLIANCES - MAJOR - REPAIRING & PARTS

OR

WASHING MACHINES, DRYERS & IRONERS - SERVICING

WHIRLPOOL APPLIANCES AUTHORIZED WHIRLPOOL SERVICE

SERVICE COMPANIES

XYZ SERVICE CO.
 123 Maple.....999-9999

4. If you need FSP® replacement parts*...

FSP is a registered trademark of Whirlpool Corporation for quality parts. Look for this symbol of quality whenever you need a replacement part for your Whirlpool appliance. FSP replacement parts will fit right and work right, because they are made to the same exacting specifications used to build every new Whirlpool appliance.

To locate FSP replacement parts in your area, refer to Step 3 above or call the Whirlpool COOL-LINE service assistance number in Step 2.

5. If you are not satisfied with how the problem was solved*...

- Contact the Major Appliance Consumer Action Panel (MACAP). MACAP is a group of independent consumer experts that voices consumer views at the highest levels of the major appliance industry.
- Contact MACAP only when the dealer, authorized servicer or Whirlpool have failed to resolve your problem.

Major Appliance Consumer Action Panel
 20 North Wacker Drive
 Chicago, IL 60606

- MACAP will in turn inform us of your action.
- * When requesting assistance, please provide: model number, serial number, date of purchase, and a complete description of the problem. This information is needed in order to better respond to your request.

WHIRLPOOL® Range Product Warranty

GR001

LENGTH OF WARRANTY	WHIRLPOOL WILL PAY FOR
FULL ONE-YEAR WARRANTY From Date of Purchase	FSP® replacement parts and repair labor to correct defects in materials or workmanship. Service must be provided by an authorized Whirlpool SM service company.
WHIRLPOOL WILL NOT PAY FOR	
<p>A. Service calls to:</p> <ol style="list-style-type: none"> 1. Correct the installation of the range product. 2. Instruct you how to use the range product. 3. Replace house fuses or correct house wiring or plumbing. 4. Replace owner accessible light bulbs. <p>B. Repairs when range product is used in other than normal, single-family household use.</p> <p>C. Pick-up and delivery. This product is designed to be repaired in the home.</p> <p>D. Damage to range product caused by accident, misuse, fire, flood, acts of God or use of products not approved by Whirlpool.</p>	

WHIRLPOOL CORPORATION SHALL NOT BE LIABLE FOR INCIDENTAL OR CONSEQUENTIAL DAMAGES. Some states do not allow the exclusion or limitation of incidental or consequential damages so this limitation or exclusion may not apply to you. This warranty gives you specific legal rights, and you may also have other rights which vary from state to state.

Outside the United States, a different warranty may apply. For details, please contact your franchised Whirlpool distributor or military exchange.

If you need service, first see the "Service and Assistance" section of this book. After checking "Service and Assistance," additional help can be found by calling our COOL-LINE® service assistance telephone number, **1-800-253-1301**, from anywhere in the U.S.

® Registered Trademark/SM Service Mark of Whirlpool Corporation